

DATA SHEET

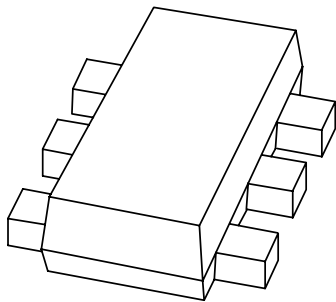

PBSS2515VPN 15 V low V_{CEsat} NPN/PNP transistor

Product specification
Supersedes data of 2001 Aug 31

2001 Nov 07

15 V low V_{CEsat} NPN/PNP transistor

PBSS2515VPN

FEATURES

- 300 mW total power dissipation
- Very small 1.6 x 1.2 mm ultra thin package
- Excellent coplanarity due to straight leads
- Low collector-emitter saturation voltage
- High current capability
- Improved thermal behaviour due to flat lead
- Replaces two SC75/SC89 packaged low V_{CEsat} transistors on same PCB area
- Reduces required PCB area
- Reduced pick and place costs.

APPLICATION

- General purpose switching and muting
- Low frequency driver circuits
- LCD backlighting
- Audio frequency general purpose amplifier applications
- Battery driven equipment (mobile phones, video cameras and hand-held devices).

DESCRIPTION

NPN/PNP low V_{CEsat} transistor pair in a SOT666 plastic package.

MARKING

TYPE NUMBER	MARKING CODE
PBSS2515VPN	N8

QUICK REFERENCE DATA

SYMBOL	PARAMETER	MAX.	UNIT
V_{CEO}	collector-emitter voltage	15	V
I_{CM}	peak collector current	1	A
R_{CEsat}	equivalent on-resistance	<500	m Ω

PINNING

PIN	DESCRIPTION
1, 4	emitter TR1; TR2
2, 5	base TR1; TR2
6, 3	collector TR1; TR2

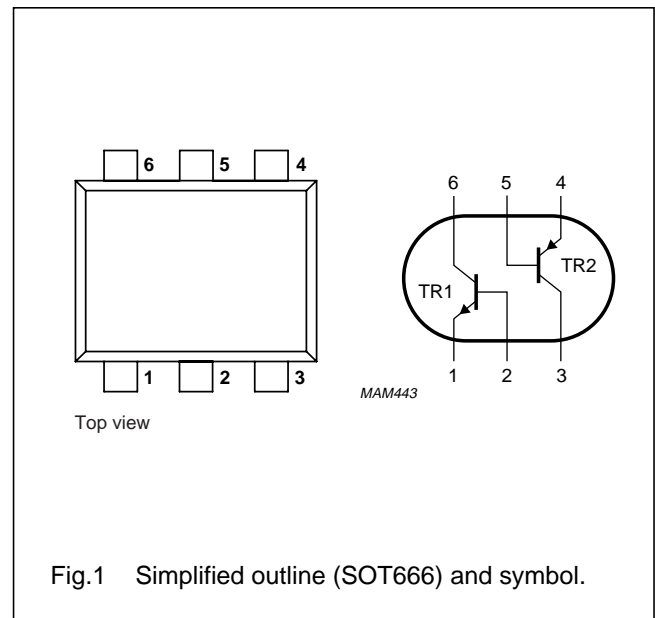

15 V low V_{CEsat} NPN/PNP transistor

PBSS2515VPN

LIMITING VALUES

In accordance with the Absolute Maximum Rating System (IEC 60134).

SYMBOL	PARAMETER	CONDITIONS	MIN.	MAX.	UNIT
Per transistor; for the PNP transistor with negative polarity					
V_{CBO}	collector-base voltage	open emitter	–	15	V
V_{CEO}	collector-emitter voltage	open base	–	15	V
V_{EBO}	emitter-base voltage	open collector	–	6	V
I_C	collector current (DC)		–	500	mA
I_{CM}	peak collector current		–	1	A
I_{BM}	peak base current		–	100	mA
P_{tot}	total power dissipation	$T_{amb} \leq 25\text{ °C}$; note 1	–	200	mW
T_{stg}	storage temperature		–65	+150	°C
T_j	junction temperature		–	150	°C
T_{amb}	operating ambient temperature		65	+150	°C
Per device					
P_{tot}	total power dissipation	$T_{amb} \leq 25\text{ °C}$; note 1	–	300	mW

Note

1. Transistor mounted on an FR4 printed-circuit board.

THERMAL CHARACTERISTICS

SYMBOL	PARAMETER	CONDITIONS	VALUE	UNIT
$R_{th\ j-a}$	thermal resistance from junction to ambient	notes 1 and 2	416	K/W

Notes

1. Transistor mounted on an FR4 printed-circuit board.
2. The only recommended soldering method is reflow soldering.

15 V low V_{CEsat} NPN/PNP transistor

PBSS2515VPN

CHARACTERISTICS

$T_{amb} = 25\text{ °C}$ unless otherwise specified.

SYMBOL	PARAMETER	CONDITIONS	MIN.	TYP.	MAX.	UNIT
Per transistor; for the PNP transistor with negative polarity						
I_{CBO}	collector-base cut-off current	$V_{CB} = 15\text{ V}; I_E = 0$	–	–	100	nA
		$V_{CB} = 15\text{ V}; I_E = 0; T_j = 150\text{ °C}$	–	–	50	μA
I_{EBO}	emitter-base cut-off current	$V_{EB} = 5\text{ V}; I_C = 0$	–	–	100	nA
h_{FE}	DC current gain	$V_{CE} = 2\text{ V}; I_C = 10\text{ mA}$	200	–	–	
		$V_{CE} = 2\text{ V}; I_C = 100\text{ mA};$ note 1	150	–	–	
		$V_{CE} = 2\text{ V}; I_C = 500\text{ mA};$ note 1	90	–	–	
V_{CEsat}	collector-emitter saturation voltage	$I_C = 10\text{ mA}; I_B = 0.5\text{ mA}$	–	–	25	mV
		$I_C = 200\text{ mA}; I_B = 10\text{ mA}$	–	–	150	mV
		$I_C = 500\text{ mA}; I_B = 50\text{ mA};$ note 1	–	–	250	mV
R_{CEsat}	equivalent on-resistance	$I_C = 500\text{ mA}; I_B = 50\text{ mA};$ note 1	–	300	<500	$\text{m}\Omega$
V_{BEsat}	base-emitter saturation voltage	$I_C = 500\text{ mA}; I_B = 50\text{ mA};$ note 1	–	–	1.1	V
V_{BE}	base-emitter turn-on voltage	$V_{CE} = 2\text{ V}; I_C = 100\text{ mA};$ note 1	–	–	0.9	V
NPN transistor						
f_T	transition frequency	$I_C = 100\text{ mA}; V_{CE} = 5\text{ V}; f = 100\text{ MHz}$	250	420	–	MHz
C_c	collector capacitance	$V_{CB} = 10\text{ V}; I_E = I_e = 0; f = 1\text{ MHz}$	–	4.4	6	pF
PNP transistor						
f_T	transition frequency	$I_C = -100\text{ mA}; V_{CE} = -5\text{ V};$ $f = 100\text{ MHz}$	100	280	–	MHz
C_c	collector capacitance	$V_{CB} = -10\text{ V}; I_E = I_e = 0; f = 1\text{ MHz}$	–	–	10	pF

Note

1. Pulse test: $t_p \leq 300\text{ }\mu\text{s}; \delta \leq 0.02$.

15 V low V_{CEsat} NPN/PNP transistor

PBSS2515VPN

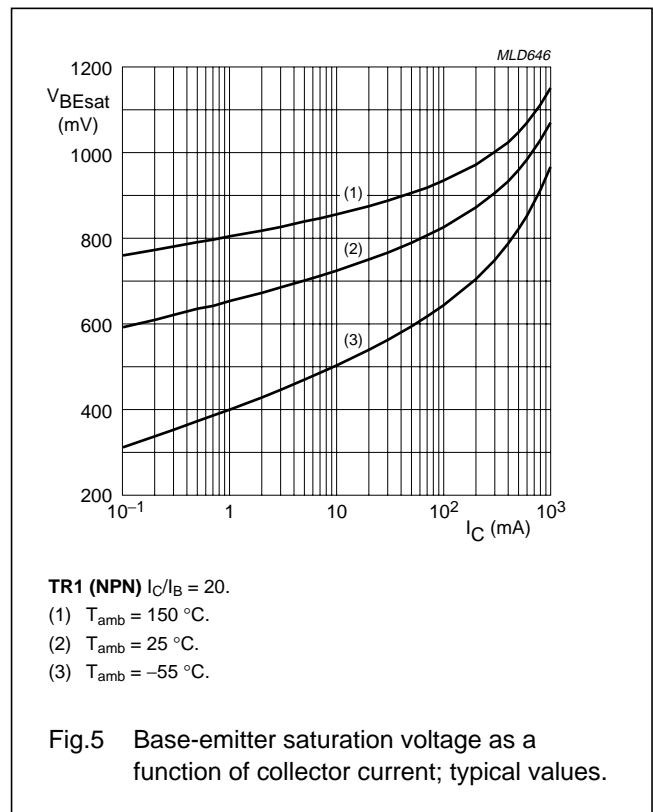
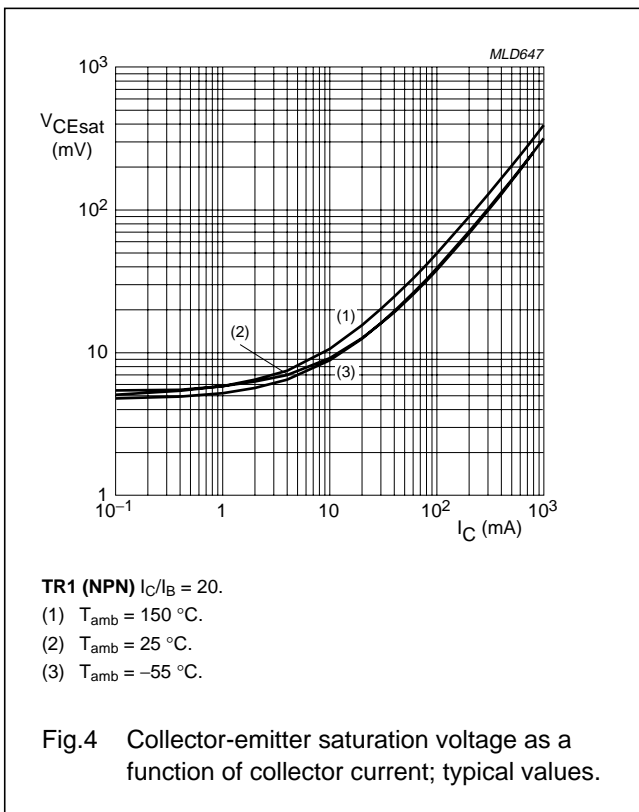
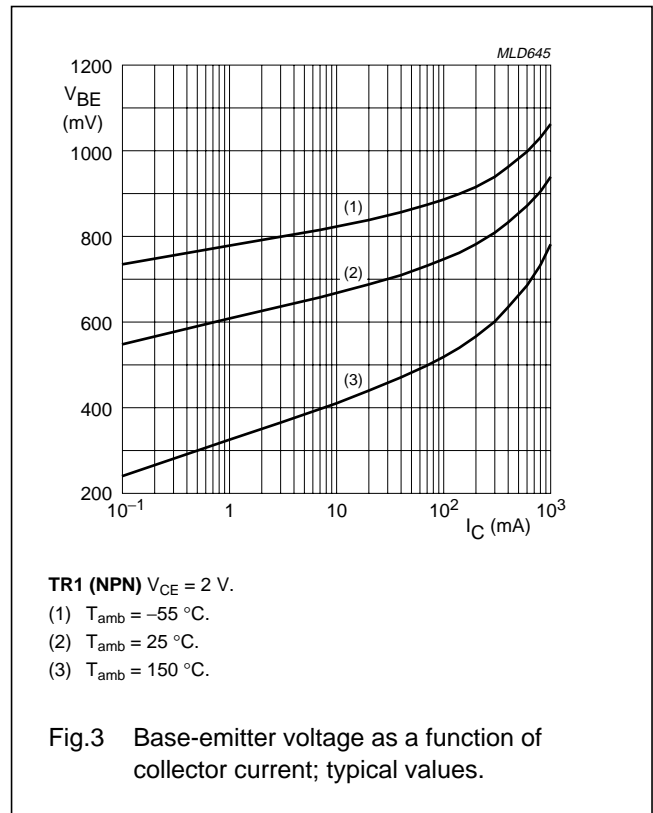
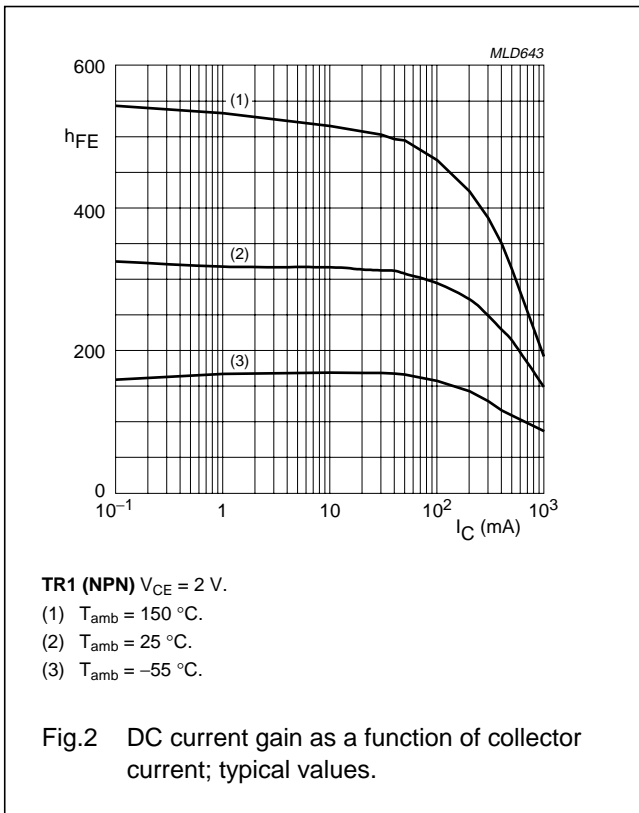

15 V low V_{CEsat} NPN/PNP transistor

PBSS2515VPN

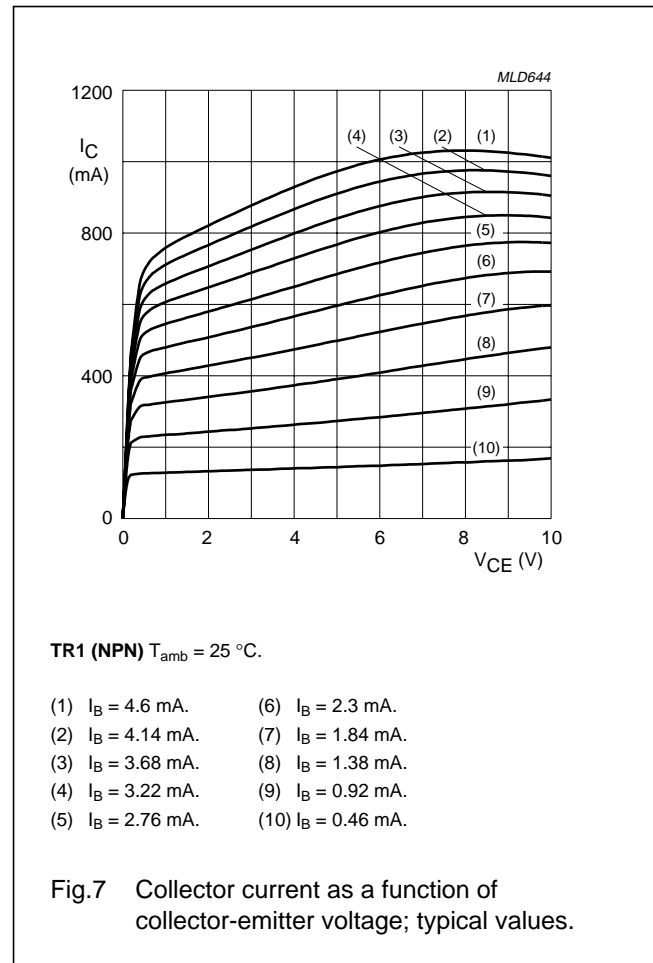
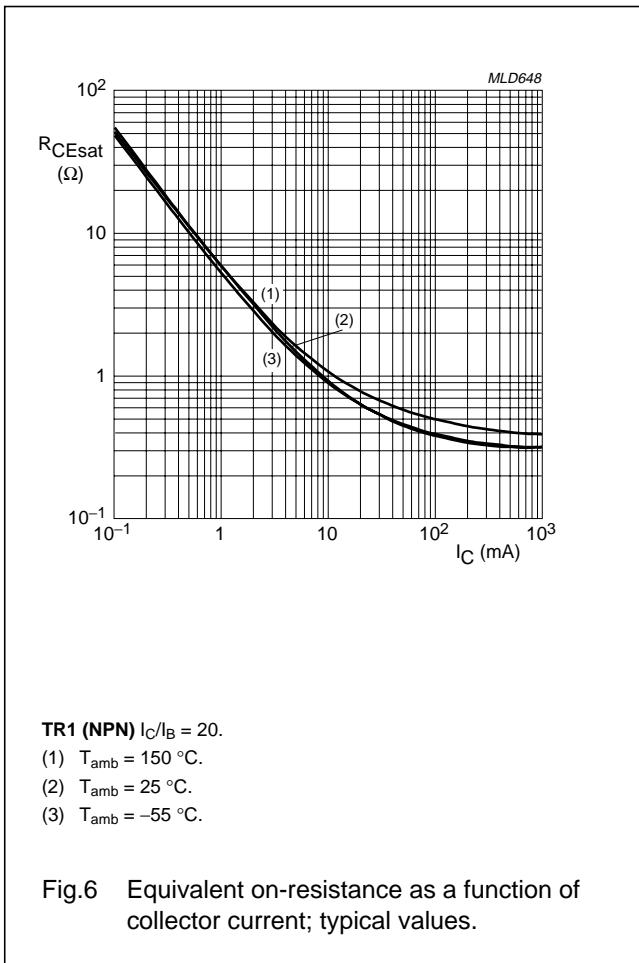

15 V low V_{CEsat} NPN/PNP transistor

PBSS2515VPN

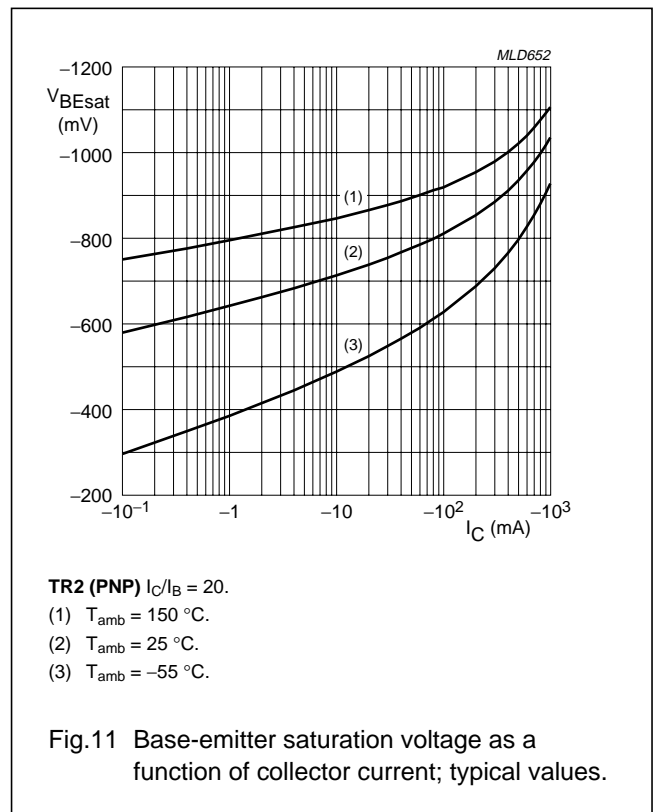
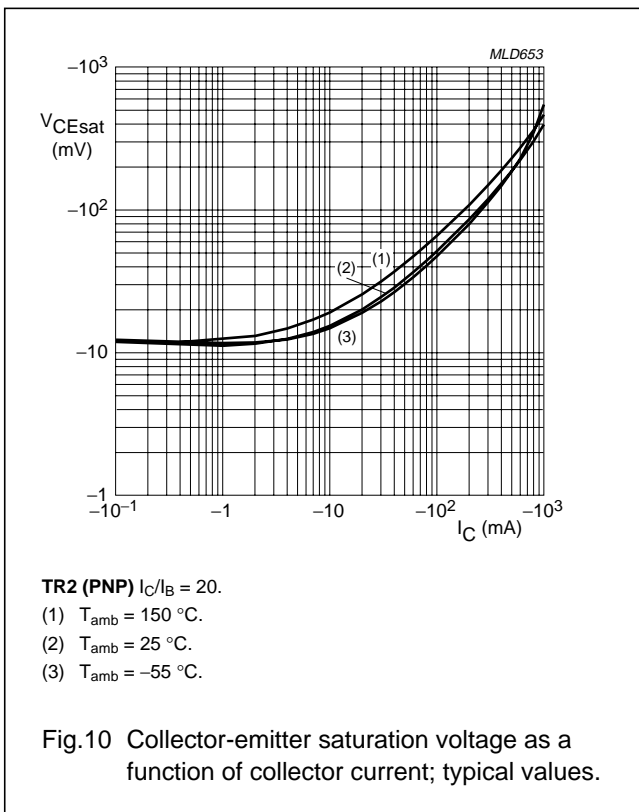
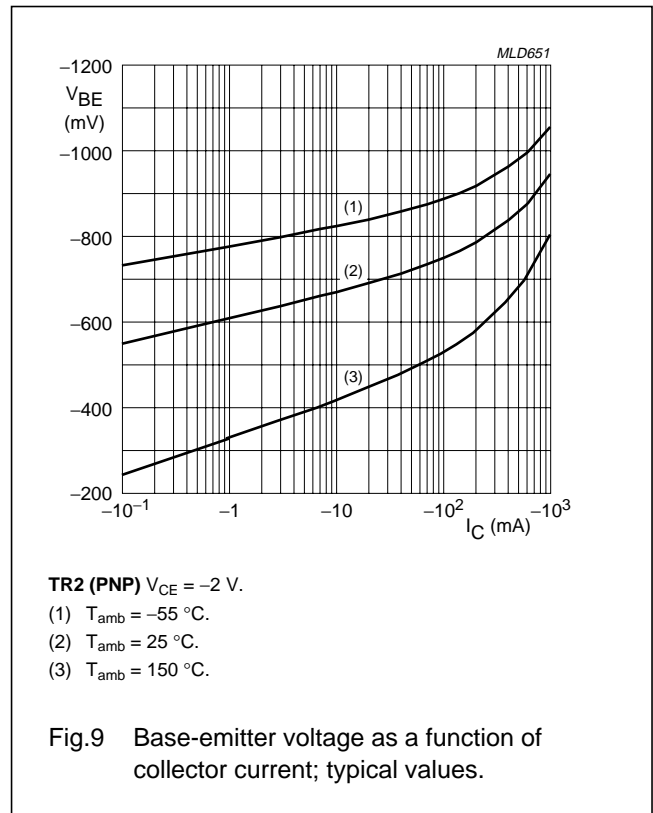
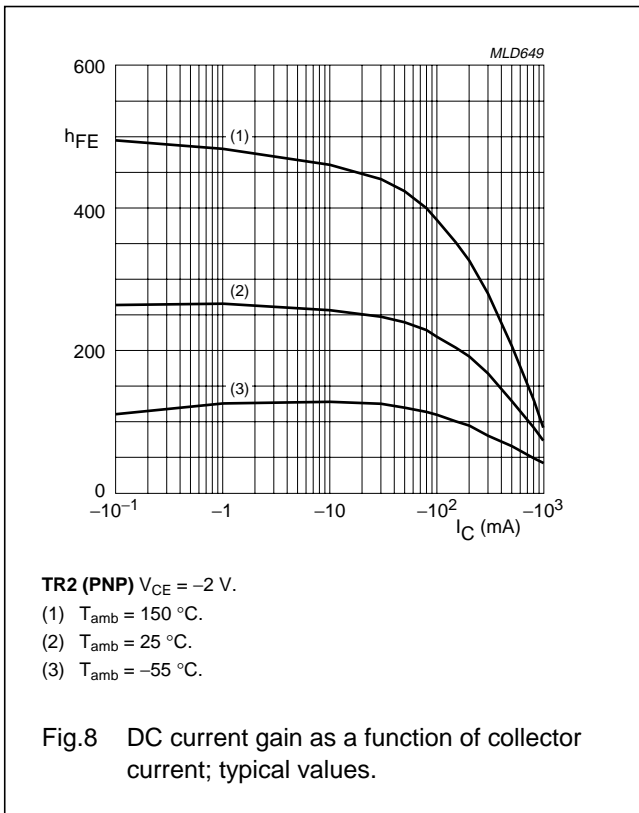

15 V low V_{CEsat} NPN/PNP transistor

PBSS2515VPN

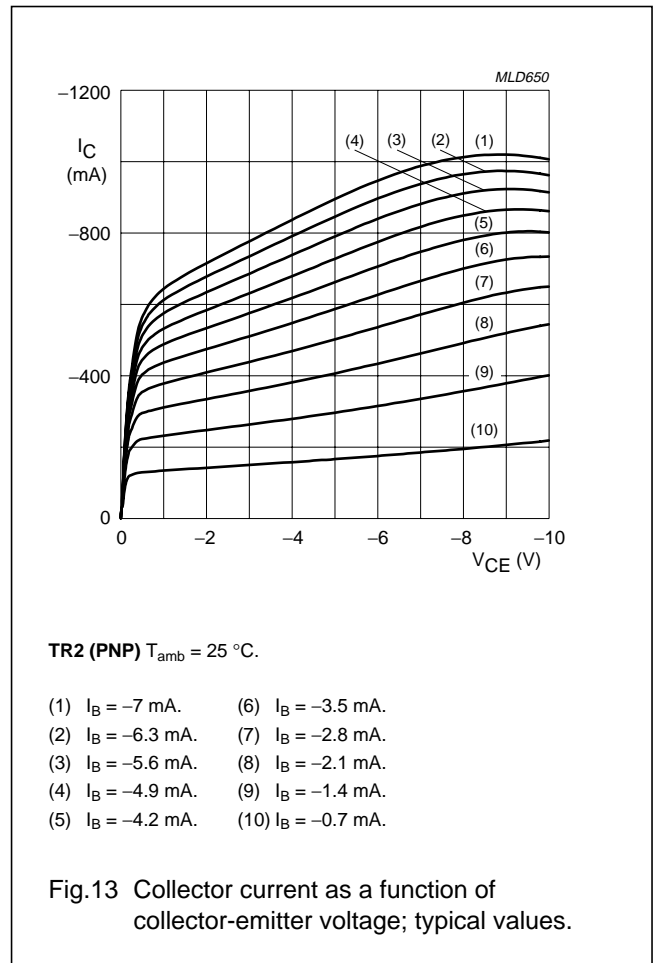
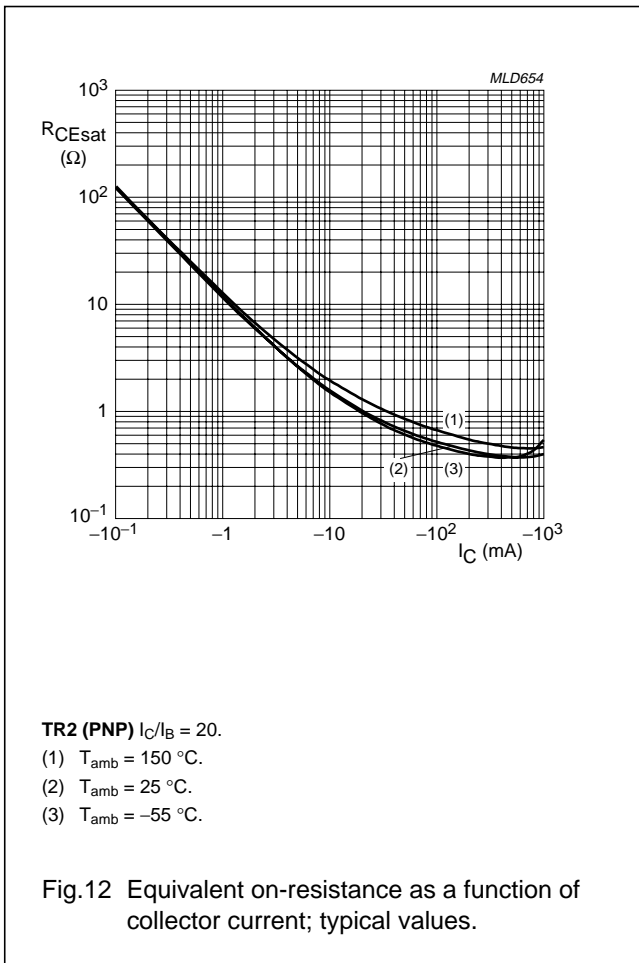

15 V low V_{CEsat} NPN/PNP transistor

PBSS2515VPN

PACKAGE OUTLINE

Plastic surface mounted package; 6 leads

SOT666

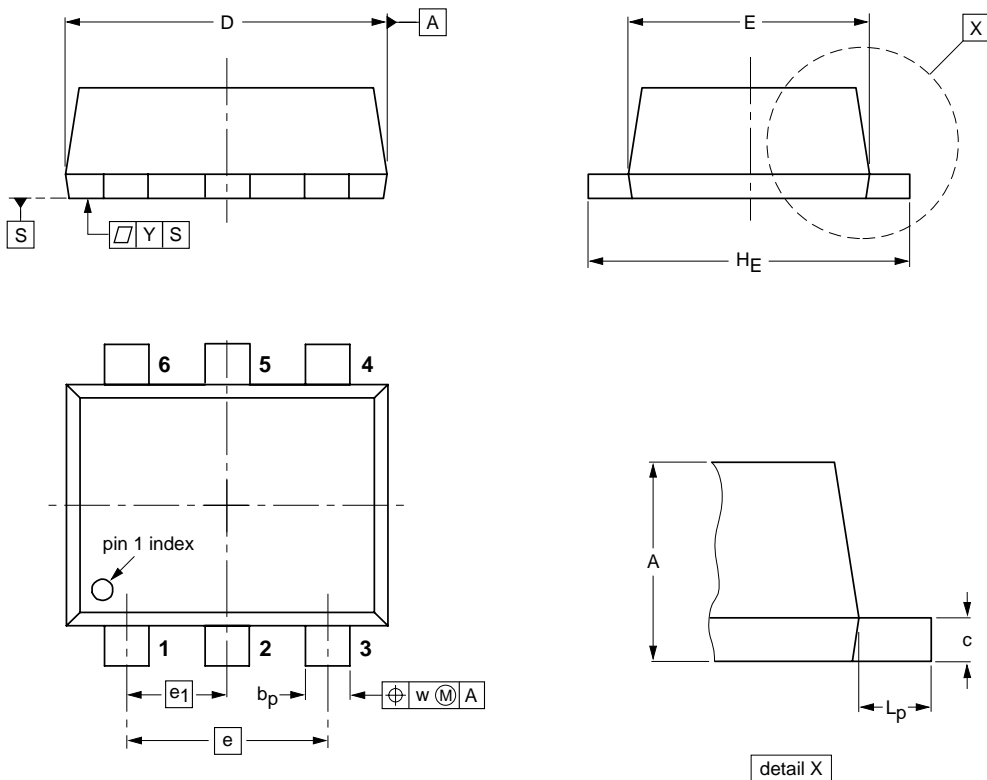

DIMENSIONS (mm are the original dimensions)

UNIT	A	b_p	c	D	E	e	e_1	H_E	L_p	w	y
mm	0.6 0.5	0.27 0.17	0.18 0.08	1.7 1.5	1.3 1.1	1.0	0.5	1.7 1.5	0.3 0.1	0.1	0.1

OUTLINE VERSION	REFERENCES				EUROPEAN PROJECTION	ISSUE DATE
	IEC	JEDEC	EIAJ			
SOT666						01-01-04 01-08-27

15 V low V_{CEsat} NPN/PNP transistor

PBSS2515VPN

DATA SHEET STATUS

DATA SHEET STATUS ⁽¹⁾	PRODUCT STATUS ⁽²⁾	DEFINITIONS
Objective data	Development	This data sheet contains data from the objective specification for product development. Philips Semiconductors reserves the right to change the specification in any manner without notice.
Preliminary data	Qualification	This data sheet contains data from the preliminary specification. Supplementary data will be published at a later date. Philips Semiconductors reserves the right to change the specification without notice, in order to improve the design and supply the best possible product.
Product data	Production	This data sheet contains data from the product specification. Philips Semiconductors reserves the right to make changes at any time in order to improve the design, manufacturing and supply. Changes will be communicated according to the Customer Product/Process Change Notification (CPCN) procedure SNW-SQ-650A.

Notes

1. Please consult the most recently issued data sheet before initiating or completing a design.
2. The product status of the device(s) described in this data sheet may have changed since this data sheet was published. The latest information is available on the Internet at URL <http://www.semiconductors.philips.com>.

DEFINITIONS

Short-form specification — The data in a short-form specification is extracted from a full data sheet with the same type number and title. For detailed information see the relevant data sheet or data handbook.

Limiting values definition — Limiting values given are in accordance with the Absolute Maximum Rating System (IEC 60134). Stress above one or more of the limiting values may cause permanent damage to the device. These are stress ratings only and operation of the device at these or at any other conditions above those given in the Characteristics sections of the specification is not implied. Exposure to limiting values for extended periods may affect device reliability.

Application information — Applications that are described herein for any of these products are for illustrative purposes only. Philips Semiconductors make no representation or warranty that such applications will be suitable for the specified use without further testing or modification.

DISCLAIMERS

Life support applications — These products are not designed for use in life support appliances, devices, or systems where malfunction of these products can reasonably be expected to result in personal injury. Philips Semiconductors customers using or selling these products for use in such applications do so at their own risk and agree to fully indemnify Philips Semiconductors for any damages resulting from such application.

Right to make changes — Philips Semiconductors reserves the right to make changes, without notice, in the products, including circuits, standard cells, and/or software, described or contained herein in order to improve design and/or performance. Philips Semiconductors assumes no responsibility or liability for the use of any of these products, conveys no licence or title under any patent, copyright, or mask work right to these products, and makes no representations or warranties that these products are free from patent, copyright, or mask work right infringement, unless otherwise specified.

15 V low V_{CEsat} NPN/PNP transistor

PBSS2515VPN

NOTES

Philips Semiconductors – a worldwide company

Contact information

For additional information please visit <http://www.semiconductors.philips.com>. Fax: +31 40 27 24825

For sales offices addresses send e-mail to: sales.addresses@www.semiconductors.philips.com.

© Koninklijke Philips Electronics N.V. 2001

SCA73

All rights are reserved. Reproduction in whole or in part is prohibited without the prior written consent of the copyright owner.

The information presented in this document does not form part of any quotation or contract, is believed to be accurate and reliable and may be changed without notice. No liability will be accepted by the publisher for any consequence of its use. Publication thereof does not convey nor imply any license under patent- or other industrial or intellectual property rights.

Printed in The Netherlands

613514/02/pp12

Date of release: 2001 Nov 07

Document order number: 9397 750 09042

Let's make things better.

**Philips
Semiconductors**



PHILIPS